

**Water Cooler Topics
I'll show you mine if you show me yours**



Charles Guarino

**Twitter @charlieguarino
Central Park Data Systems, Inc.**

About The Speaker

With an IT career spanning over 30 years, Charles Guarino has been a consultant for most of them. Since 1995 he has been founder and President of Central Park Data Systems, Inc., a New York area based IBM midrange consulting and corporate training company. In addition to being a professional speaker across the United States and Europe, he is a frequent contributor of technical and strategic articles and webcasts for the IT community. He is a member of COMMON's Speaker Excellence Hall of Fame and also Long Island Software and Technology Network's Twenty Top Techies. In 2015 Charles became the recipient of the Al Barsa Memorial Scholarship Award. Additionally, he serves as a member of COMMON's Strategic Education Team (SET) and is also a past president and monthly Q&A host of LISUG, a Long Island IBM i User's Group www.lisug.org.

Charles can be reached at cguarino@centralparkdata.com.

LinkedIn - <http://www.linkedin.com/in/guarinocharles>

Twitter - @charlieguarino

What We'll Cover ...

- Where do you fit in?
- IBM i
- Rational Developer for i (RDi)
- Current events
- Dark Web
- Free Apps?
- Hacking Around
- Wrap-up

Reciprocal responsibilities employer and employee



Business Law & Taxes

What are My Responsibilities to Employees as an Employer?

Employer and Employee Responsibilities to Each Other



<https://www.thebalance.com/what-are-my-responsibilities-to-employees-as-an-employer-397923>

Constant Struggle? - Employer



- Paying Employees
- Reporting to Employees
- FMLA (when 50 or more employees)
- Provide a safe and healthy place to work
- Equal opportunity in selecting, testing and hiring

Constant Struggle? - Employee



- Obedience
- Dealing honestly with the employer
- Work with reasonable care and skill
- Don't disclose confidential information
- Care for employer's property and equipment

Job or Career?

	Career	Job
What is it?	A career is the pursuit of a lifelong ambition or the general course of progression towards lifelong goals.	Job is an activity through which an individual can earn money. It is a regular activity in exchange of payment.
Requirements	Usually requires special learning that includes individualized components that develop abilities beyond that which training is capable of.	Education or Special training may or may not be required
Risk taking	A career may not mean stability of work as it encourages one to take risks. The risks are often internal and therefore planned.	A job is "safe", as stability of work and income is there. However shifting priorities, especially in resource jobs, can abruptly change the demand and require relocation which is an unstable factor. Risks may be completely external.
Time	Long term	Short term
Income	Varies depending on value to society or to some other entity. Non-monetary benefits may be higher. Salary is more common.	Varies by demand. More likely to be wage.
Contribution to society	May have high value as social change/progress may be possible.	May actually have a negative impact when counterproductive social practices are continued in the name of protecting jobs.

http://www.diffen.com/difference/Career_vs_Job

What's Your Value Add?

“As someone in IT, if you attend a corporate meeting and are given technology ideas from management, you’re doing it all wrong.”



Human Resources

Examples of Value Add

[f SHARE](#) [p PIN](#) [✉ EMAIL](#)



Ugurhan Betin/E+/Getty Images

By [Susan M. Heathfield](#)
Updated August 29, 2016

Your value add is the real contribution you make to your organization's success. While doing the activities listed in your job description or your job specification is important and makes a contribution, your value add moves beyond activities or actions performed and illuminates, instead, the actual contributions you made to your organization's success.

What is your work ethic?

"It is often easier to ask for forgiveness than ask for permission."

Grace Hopper

American Computer Scientist
United States Navy rear admiral

Developed first compiler
Led the effort to create COBOL



What We'll Cover ...

- Where do you fit in?
 - IBM i
- Rational Developer for i (RDi)
- Current events
- Dark Web
- Free Apps?
- Hacking Around
- Wrap-up

“IBM Power Systems is committed to the success and ongoing development of IBM i.”

IBM

June 9, 2017

Dear IBM i clients and partners,

I would like to take this opportunity to reaffirm the commitment that IBM has made with regard to RPG, COBOL and the IBM i Development suite of tools. Recently, the team responsible for developing the compilers and tools for IBM i have moved into the IBM i Development organization. This will allow more synergy between the development of the languages and the development of the operating system.

IBM Power Systems is committed to the success and ongoing development of IBM i. This includes the ILE RPG and ILE COBOL compilers and associated development tools. This ongoing commitment has been illustrated with such enhancements as RPG Open Access, and Free Format RPG. Both the ability to interface traditional RPG programs to other devices and technologies and the natural evolution of RPG to free format are significant enhancements supporting client requirements for modernization of their applications. In parallel with our most recent IBM i 7.3 release, new extensions to the RPG and COBOL languages were also announced.

We gather requirements for these Application Development environments for IBM i from a number of customer advisory councils and we balance those requirements with our study of industry trends. As the delivery of updates to the compilers and Rational Developer for i unfolds over the next several quarters you will see further evidence of our eagerness to listen, to collaborate, and to deliver the improvements you consider most valuable.

IBM Power is committed to your success - to helping you realize business value from your applications and to extend that value with new business opportunities. We thank you for your business and your confidence in the future of one of the world's most durable and productive platforms for business.

Sincerely,



Steve Sibley
Vice President, Business Line Executive
IBM Cognitive Systems

What We'll Cover ...

- Where do you fit in?
- IBM i
- Rational Developer for i (RDi)
- Current events
- Dark Web
- Free Apps?
- Hacking Around
- Wrap-up

Compare to SEU? I don't think so!

*“A user interface is like a joke.
If you have to explain it,
it's not that good.”*

- Martin LeBlanc

If RDi were free would you take it for a ride?

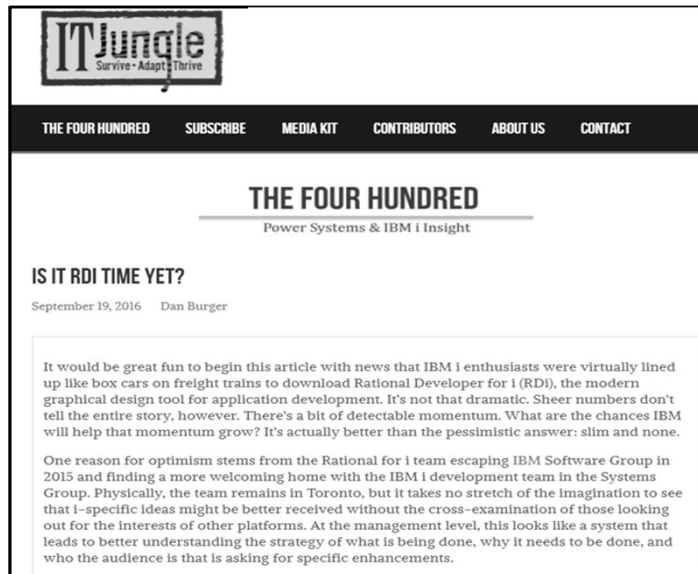

The screenshot shows the IT Jungle website header with the logo and tagline 'Survive • Adapt • Thrive'. Below the header is a navigation bar with links: THE FOUR HUNDRED, SUBSCRIBE, MEDIA KIT, CONTRIBUTORS, ABOUT US, CONTACT. The main content area features the title 'THE FOUR HUNDRED' with a subtitle 'Power Systems & IBM i Insight'. The article title is 'IS IT RDI TIME YET?' by Dan Burger, dated September 19, 2016. The article text discusses the challenges of IBM i development and the potential of RDi.

<https://www.itjungle.com/2016/09/19/tfh091916-story03/>

“Like a shot in the arm”

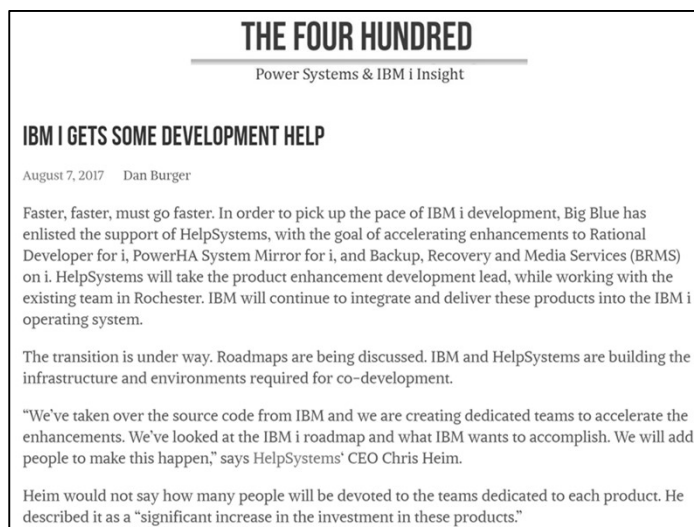

The screenshot shows the IT Jungle website header with the logo and tagline 'Survive • Adapt • Thrive'. Below the header is a navigation bar with links: THE FOUR HUNDRED, SUBSCRIBE, MEDIA KIT, CONTRIBUTORS, ABOUT US, CONTACT. The main content area features the title 'THE FOUR HUNDRED' with a subtitle 'Power Systems & IBM i Insight'. The article title is 'IBM I GETS SOME DEVELOPMENT HELP' by Dan Burger, dated August 7, 2017. The article text discusses the support of HelpSystems for IBM i development and the transition of development lead.

<https://www.itjungle.com/2017/08/07/ibm-gets-development-help/>

Rational Developer for i

RDi may be the most important product in this partnership. IBM i developers are notorious for clinging to their green-screen development environments.

It's taking forever to get RDi into the mainstream of IBM i development, although the pace seems to have picked up a notch or two in the past 12 to 24 months.

Regardless, modern application development and the adoption of RDi is critical to the future of the platform.

IBM's Request for Enhancements Community

The screenshot shows the IBM RFE Community website interface. At the top, it says "developerWorks" and "IBM RFE Community". Below the header, there are navigation tabs: "Overview", "Search", "Submit", "My stuff", "Groups", and "Help". A welcome message reads: "Welcome Request for Enhancement (RFE) Community users! Here you have an opportunity to collaborate directly with the IBM product development teams and other product users." There is a filter section: "Filter the page content by brand and product" with a dropdown menu set to "All products" and a search box. Below this, a list of requests is shown. The second request is highlighted with a red box:

Votes	Request Title	Status	Product
282	Ability to define drill-throughs in Cognos Analytics dashboards	Uncommitted Candidate	Cognos Analytics
227	RDi Lite, RDi Premium RDi Lite, RDi Pro, RDi Premium versions needed	Under Consideration	Developer for Power Systems
201	Cognos 11 Default action for running report is missing		

On the right side, there is a "Your Ideas matter!" section with statistics: "As of today: 1256 new, 5018 planned, 16598 delivered". Below that, it shows "29021 users, 214909 votes, 184191 comments". A "Spotlight" section lists updates: "RFE Community is updated (Release 20)", "RFE Community is updated (Release 19)", and "RFE Community is updated (Release 18)". At the bottom right, there are links for "See all announcements" and "Give us feedback".

<https://www.ibm.com/developerworks/rfe>

COMMON Americas Advisory Council

developerWorks.

Total comments (18)

Show: >

The CAAC has reviewed this requirement and recommends that IBM view this as a medium-to-high priority requirement that should be addressed. Implementing this RFE is good for the platform; it will result in additional users of RDi and as a result, moving applications forward.

Background: The COMMON Americas Advisory Council (CAAC) members have a broad range of experience in working with small and medium-sized IBM i customers. CAAC has a key role in working with IBM i development to help assess the value and impact of individual RFEs on the broader IBM i community, and has therefore reviewed your RFE.

For more information about CAAC, see www.common.org/caac

For more details about CAAC's role with RFEs, see <http://www.ibmssystemsmag.com/Blogs/i-Can/May-2017/COMMON-Americas-Advisory-Council-%28CAAC%29-and-RFEs/>

Dawn May - CAAC Program Manager

Posted by DawnMay on 29 Aug 2017

 Report abuse

A free version of RDi?



THE FOUR HUNDRED SUBSCRIBE MEDIA KIT CONTRIBUTORS ABOUT US CONTACT

THE FOUR HUNDRED

Power Systems & IBM i Insight

IF RDI WAS FREE, WOULD YOU GO FOR A RIDE?

August 16, 2017 Dan Burger

Some interesting developments have occurred with the Rational Developer for i (RDi) team. First came the extraction from IBM Software Group and relocation within the IBM i development organization. Then came the integration of RDi development efforts involving IBM and HelpSystems. What's next? Perhaps a free lightweight version of RDi designed to entice more IBM i developers to trade in their old tools and take a closer look at what they can gain with RDi.

A new request for enhancement (RFE #I08558) may gather enough momentum to bring a free RDi to market. That leads to the question of whether price is a real barrier to the tool's adoption?

"RDi pricing makes management hesitant to allocate budget," says the RFE originator Hassan Farooq. "They can't see the return on investment. To make ROI more obvious, we need a light version of RDi that is free and includes the basic functions of SEU: editing, compiling, running and debugging. The remaining hundreds of features can remain in the paid version."

He goes on to say: "The goal is the get off green screen, which is an existential threat to IBM i in my experience."

<https://www.itjungle.com/2017/08/16/rdi-free-go-ride/>

Free RDi Training on YouTube

The screenshot shows a YouTube search interface with the search bar containing 'ibm rdi'. Below the search bar, it indicates 'About 661 results'. A list of video results is displayed, including:

- RDi Webcast** by Royal Cyber Inc. (1.3K views, 3 years ago). Description: For More Information Visit: www.royalcyber.com Contact us today at: info.us@royalcyber.com or Call us at: +1.630.355.6292.
- Popular Videos - IBM RPG** (IBM RPG - Topic). Includes 'Intro to RPG IV Lesson 1' (8:31) and '1969 IBM System/3 promotional ad - midrange, minicomputer, Computer History, RPG' (12:12). Includes a link to 'VIEW FULL PLAYLIST (200 VIDEOS)'.
- Introduction to free form RPG using RDi** by Charles Guarino (5.7K views, 3 years ago). Description: Description.
- RPG and RDi Getting Better All The Time** by Charles Guarino (920 views, 8 months ago). Description: How is IBM keeping RPG and RDi relevant? This short video shows recent changes with a nod always toward application and ...
- Rational Developer for i (RDi)** by PKSoftware. Includes 'PKS WEBINAR-TAG - BLOCK 2: RDi & eXplain' (54:22) and 'Zeitgemäß Software entwickeln: RDi & Beyond' (54:52). Includes a link to 'VIEW FULL PLAYLIST (10 VIDEOS)'.

An arrow points from the text '“IBM RDi”' to the search bar.

What We'll Cover ...

- Where do you fit in?
- IBM i
- Rational Developer for i (RDi)
- Current events
- Dark Web
- Free Apps?
- Hacking Around
- Wrap-up



A new currency is born

Bitcoin: A Peer-to-Peer Electronic Cash System

Satoshi Nakamoto
satoshi@gmx.com
www.bitcoin.org

Abstract. A purely peer-to-peer version of electronic cash would allow online payments to be sent directly from one party to another without going through a financial institution. Digital signatures provide part of the solution, but the main benefits are lost if a trusted third party is still required to prevent double-spending. We propose a solution to the double-spending problem using a peer-to-peer network. The network timestamps transactions by hashing them into an ongoing chain of hash-based proof-of-work, forming a record that cannot be changed without redoing the proof-of-work. The longest chain not only serves as proof of the sequence of events witnessed, but proof that it came from the largest pool of CPU power. As long as a majority of CPU power is controlled by nodes that are not cooperating to attack the network, they'll generate the longest chain and outpace attackers. The network itself requires minimal structure. Messages are broadcast on a best effort basis, and nodes can leave and rejoin the network at will, accepting the longest proof-of-work chain as proof of what happened while they were gone.

1. Introduction

Commerce on the Internet has come to rely almost exclusively on financial institutions serving as trusted third parties to process electronic payments. While the system works well enough for most transactions, it still suffers from the inherent weaknesses of the trust based model. Completely non-reversible transactions are not really possible, since financial institutions cannot avoid mediating disputes. The cost of mediation increases transaction costs, limiting the minimum practical transaction size and cutting off the possibility for small casual transactions, and there is a broader cost in the loss of ability to make non-reversible payments for non-reversible services. With the possibility of reversal, the need for trust spreads. Merchants must be wary of their customers, hassling them for more information than they would otherwise need. A certain percentage of fraud is accepted as unavoidable. These costs and payment uncertainties can be avoided in person by using physical currency, but no mechanism exists to make payments over a communications channel without a trusted party.

<https://bitcoin.org/bitcoin.pdf>

<http://www.learnliberty.org/blog/demystifying-bitcoin>

Learn Liberty Explore the ideas of a **free society**
A PROJECT OF IHS

TOPICS PROGRAMS OPPORTUNITIES BLOG WHO WE ARE COMMUNITY



Demystifying Bitcoin

WILLIAM J. LUTHER | FEBRUARY 15, 2017 | BASIC ECONOMICS

The image shows a screenshot of a blog post. At the top, it says 'Learn Liberty' with the tagline 'Explore the ideas of a free society' and 'A PROJECT OF IHS'. Below this is a navigation menu with links for 'TOPICS', 'PROGRAMS', 'OPPORTUNITIES', 'BLOG', 'WHO WE ARE', and 'COMMUNITY', along with a search bar. The main content area features a photograph of a man in a striped shirt pointing his right index finger at a Bitcoin symbol. Above the Bitcoin symbol are five other currency symbols: a dollar sign (\$), a Euro sign (€), a Yen sign (¥), and a Pound sign (£). Below the photograph, the title 'Demystifying Bitcoin' is displayed in a large, bold font. At the bottom of the post, there is a line of small text: 'WILLIAM J. LUTHER | FEBRUARY 15, 2017 | BASIC ECONOMICS'.

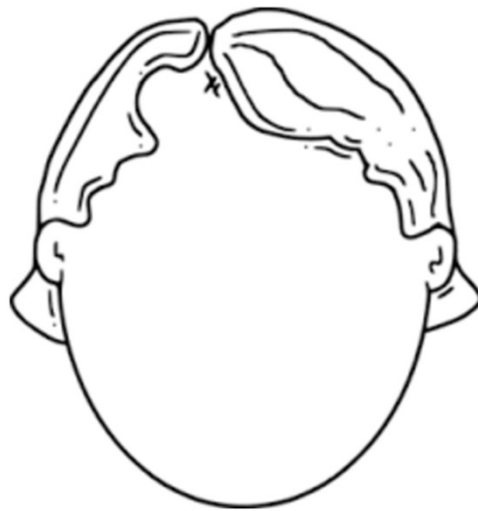

Satoshi Nakamoto

FINANCE

FINANCE | BANKS | INVESTING | WALL STREET | HEDGE FUNDS | M&A | INSURAN

SEC rejects application to list Bitcoin ETF

Friday, 10 Mar 2017 | 5:17 PM ET

REUTERS



The U.S. Securities and Exchange Commission on Friday denied a request to list what would have been the first U.S. exchange-traded

Don't write off bitcoin yet, despite blow to Winklevoss plan



Tyler Winklevoss, left, and Cameron Winklevoss. Pic: AP

The Australian 12:00PM March 16, 2017

1 [Facebook] [Twitter] [Email] [More] Save



RICHARD GLUYAS
Business correspondent Melbourne @Gluyasr

It seems that bitcoin's prophets of doom celebrated prematurely after the US Securities and Exchange Commission comprehensively knocked back the Winklevoss brothers' bid to create an exchange-traded fund tied to the price of the world's largest cryptocurrency.

<http://www.theaustralian.com.au/business/opinion/richard-gluyas-banking/dont-write-off-bitcoin-yet-despite-blow-to-winklevoss-plan/news-story/cdf087db8d30fc0b73e65b95de5ba95d>



TRADE

STAKE

MINE

INVEST

Invest in Cryptocurrency



bitconnect Coin

THE CRYPTOCURRENCY R E V O L U T I O N

INVEST NOW

TOTAL COIN SUPPLY  28 MILLION ONLY

<http://www.expedia.com/Checkout/BitcoinTermsAndConditions>

Expedia
+bitco

Bitcoin Terms & Conditions

These Bitcoin Terms & Conditions ("Terms & Conditions") apply to your use of Bitcoin as your selected payment method. Please read these Terms & Conditions carefully. By using Bitcoin as your method of payment, you acknowledge and agree to be bound by these Terms & Conditions. These Terms & Conditions apply in addition to the terms and conditions contained in our Website Terms of Use. If there is a conflict between these Terms & Conditions and our Website Terms of Use with respect to Bitcoin transactions, these Terms & Conditions apply. If you do not agree with all of these Terms & Conditions, do not select Bitcoin as your payment method.

Paying with Bitcoin

Powered by Coinbase. Our acceptance of Bitcoin is powered by our partner, Coinbase. We do not guarantee and are not responsible for the availability of Coinbase's services. To complete your booking, you will be re-directed to Coinbase's website, where you will see the total cost of your booking in Bitcoin, based on an exchange rate set by Coinbase. The Bitcoin price for your booking will remain valid for 10 minutes. If you do not initiate a payment during this time, the Bitcoin exchange rate will be updated and the Bitcoin price for your booking may change.

Bitcoin network transaction fees. As with nearly all Bitcoin transactions, a very small transaction fee (a "miner's fee") will be added by the Bitcoin network to the total cost in Bitcoin of your booking if you are sending Bitcoin from a non-Coinbase wallet. This fee covers the cost of verifying Bitcoin transactions. Expedia has no control over this fee and does not receive any portion of the fee.

Bitcoin transactions are final. Once you initiate a Bitcoin transaction, you cannot cancel it (provided however that you may seek a refund per our refund policy described below). This is inherent in the nature of the Bitcoin network, not a policy set by Expedia.

Under payments and over payments. If, using a Coinbase wallet, you attempt to initiate a payment of Bitcoins different from the exact cost of the booking indicated by Coinbase, your booking will not complete. If, using a non-Coinbase wallet, you initiate a payment of Bitcoins different from the exact cost (plus miner's fees) of the booking indicated by Coinbase your booking will not complete however your payment maybe processed by the Bitcoin network, in which case your payment will be refunded by Coinbase. After a failed payment you will be required to re-submit payment for the correct amount in order to complete the booking and the Bitcoin exchange rate may update.

Transactions complete once confirmed. Once a Bitcoin transaction is submitted to the Bitcoin network, it will be unconfirmed for a period of time (usually about an hour, but sometimes longer) pending full verification of the transaction by the Bitcoin network. A transaction is not complete until it is fully verified.

<https://news.bitcoin.com/bitcoin-pizza-day-anniversary>



<https://en.wikipedia.org/wiki/Blockchain>

Blockchain

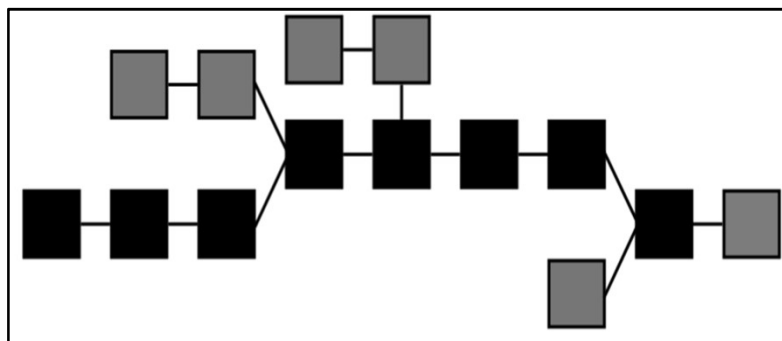

<http://bitcoinwhoswho.com/blog/2016/01/30/a-living-currency-an-interview-with-jercos-party-to-first-bitcoin-pizza-transaction/>

INTERVIEWS

A LIVING CURRENCY: AN INTERVIEW WITH "JERCOS", PARTY TO FIRST BITCOIN PIZZA TRANSACTION

🕒 JANUARY 30, 2016
👤 BITCOINWHOSWHO
💬 LEAVE A COMMENT



Jercos

Living Currency

An Interview with Jeremy Sturdivant aka "Jercos", the young man who sold two pizzas for 10,000 BTC in what would come to be recognized as the first transaction involving a tangible good or service in bitcoin history. Now recognized as "bitcoin pizza day".

On May 22, 2010 Laszlo Hanyecz now famously declared success in his four day quest to trade 10,000 BTC for "a couple of pizzas", posting on a bitcointalk forum page:

"I just want to report that I successfully traded 10,000 bitcoins for pizza. Thanks jercos!"

At the time the transaction was valued at \$25. A year later it was \$57,700. Five years later the value is about \$2.3 million after having been as high as \$10+ million in late 2013. The transaction is now firmly entrenched in bitcoin lore, memorialized on several bitcoin history sites and inspiring a "pizza index" (at least for a little while).

<https://blockchain.info/tx/a1075db55d416d3ca199f55b6084e2115b9345e16c5cf302fc80e9d5fbf5d48d>

BLOCKCHAIN
WALLET
CHARTS
STATS
MARKETS
API

🔍 Search for block hash, transaction, address, etc

Transaction View information about a bitcoin transaction

a1075db55d416d3ca199f55b6084e2115b9345e16c5cf302fc80e9d5fbf5d48d

1XPTgDRhN8RFznzWCddbd9iKZatrVH4
➔
17SkEw2md5avVnyYgj6RXuQKNwkXaxFyQ

10,000 BTC

Summary	
Size	23620 (bytes)
Received Time	2010-05-22 18:16:31
Included In Blocks	57043 (2010-05-22 18:16:31 + 0 minutes)
Confirmations	399758 Confirmations
Relayed by IP	0.0.0.0 (whols)
Visualize	View Tree Chart

Inputs and Outputs	
Total Input	10,000.99 BTC
Total Output	10,000 BTC
Fees	0.99 BTC
Fee per byte	4,191.363 sat/B
Estimated BTC Transacted	10,000 BTC
Scripts	Show scripts & coinbase

10,000 BTC =

<https://blockchain.info/tx/a1075db55d416d3ca199f55b6084e2115b9345e16c5cf302fc80e9d5fbf5d48d>

BLOCKCHAIN WALLET CHARTS STATS MARKETS API

Transaction View information about a bitcoin transaction

a1075db55d416d3ca199f55b6084e2115b9345e16c5cf302fc80e9d5fbf5d48d

1XPTgDRhN8RFznIWCddobD9IKZatrVH4 → 17SkEw2md5avVnyYgj6RiXUqKNwXaxFyQ

\$ 11,639,400.00

\$ 11,639,400.00

Summary		Inputs and Outputs	
Size	23620 (bytes)	Total Input	\$ 11,640,552.30
Received Time	2010-05-22 18:16:31	Total Output	\$ 11,639,400.00
Included In Blocks	57043 (2010-05-22 18:16:31 + 0 minutes)	Fees	\$ 1,152.30
Confirmations	399758 Confirmations	Fee per byte	4,191.363 sat/B
Relayed by IP	0.0.0.0 (whois)	Estimated BTC Transacted	\$ 11,639,400.00
Visualize	View Tree Chart	Scripts	Show scripts & coinbase

\$11,639,400.00
March 15th, 2017

<https://blockchain.info/tx/a1075db55d416d3ca199f55b6084e2115b9345e16c5cf302fc80e9d5fbf5d48d>

BLOCKCHAIN WALLET CHARTS STATS MARKETS API

Transaction View information about a bitcoin transaction

a1075db55d416d3ca199f55b6084e2115b9345e16c5cf302fc80e9d5fbf5d48d

1XPTgDRhN8RFznIWCddobD9IKZatrVH4 → 17SkEw2md5avVnyYgj6RiXUqKNwXaxFyQ

\$ 12,079,400.00

\$ 12,079,400.00

Summary		Inputs and Outputs	
Size	23620 (bytes)	Total Input	\$ 12,080,595.86
Received Time	2010-05-22 18:16:31	Total Output	\$ 12,079,400.00
Included In Blocks	57043 (2010-05-22 18:16:31 + 0 minutes)	Fees	\$ 1,195.86
Confirmations	404224 Confirmations	Fee per byte	4,191.363 sat/B
Relayed by IP	0.0.0.0 (whois)	Estimated BTC Transacted	\$ 12,079,400.00
Visualize	View Tree Chart	Scripts	Show scripts & coinbase

\$12,079,400.00
April 10th, 2017

Not bad for 4 weeks "work"

• 2017 •

January							February							March							April						
S	M	T	W	T	F	S	S	M	T	W	T	F	S	S	M	T	W	T	F	S	S	M	T	W	T	F	S
1	2	3	4	5	6	7	1	2	3	4				1	2	3	4				1	2	3	4	5	6	7
8	9	10	11	12	13	14	5	6	7	8	9	10	11	5	6	7	8	9	10	11	2	3	4	5	6	7	8
15	16	17	18	19	20	21	12	13	14	15	16	17	18	12	13	14	15	16	17	18	9	10	11	12	13	14	15
22	23	24	25	26	27	28	19	20	21	22	23	24	25	19	20	21	22	23	24	25	16	17	18	19	20	21	22
29	30	31					26	27	28					26	27	28	29	30	31	☾ 24	25	26	27	28	29		

May							June							July							August						
S	M	T	W	T	F	S	S	M	T	W	T	F	S	S	M	T	W	T	F	S	S	M	T	W	T	F	S
1	2	3	4	5	6		1	2	3				1	2	3	4				1	2	3	4	5			
7	8	9	10	11	12	13	4	5	6	7	8	9	10	2	3	4	5	6	7	8	6	7	8	9	10	11	12
14	15	16	17	18	19	20	11	12	13	14	15	16	17	9	10	11	12	13	14	15	13	14	15	16	17	18	19
21	22	23	24	25	26	27	18	19	20	21	22	23	24	16	17	18	19	20	21	22	20	21	22	23	24	25	26
28	29	30	31				25	26	27	28	29	30	☾ ☾ 25	26	27	28	29	27	28	29	30	31					

September							October							November							December						
S	M	T	W	T	F	S	S	M	T	W	T	F	S	S	M	T	W	T	F	S	S	M	T	W	T	F	S
				1	2		1	2	3	4	5	6	7	1	2	3	4				1	2	3	4	5	6	7
3	4	5	6	7	8	9	8	9	10	11	12	13	14	5	6	7	8	9	10	11	3	4	5	6	7	8	9
10	11	12	13	14	15	16	15	16	17	18	19	20	21	12	13	14	15	16	17	18	10	11	12	13	14	15	16
17	18	19	20	21	22	23	22	23	24	25	26	27	28	19	20	21	22	23	24	25	17	18	19	20	21	22	23
24	25	26	27	28	29	30	29	30	31					26	27	28	29	30	☾ 25	26	27	28	29	30			

\$440,000.00

<https://blockchain.info/tx/a1075db55d416d3ca199f55b6084e2115b9345e16c5cf302fc80e9d5fbf5d48d>

BLOCKCHAIN WALLET CHARTS STATS MARKETS API

Transaction View information about a bitcoin transaction

a1075db55d416d3ca199f55b6084e2115b9345e16c5cf302fc80e9d5fbf5d48d

1XPTgDRhN8RFnznWCddobD9IKZatrVH4 ➔ 17SkEw2md5avVNyYgj6R0XuQKNwKXaxFyQ \$ 15,698,100.00

Summary		Inputs and Outputs	
Size	23620 (bytes)	Total Input	\$ 15,699,654.11
Received Time	2010-05-22 18:16:31	Total Output	\$ 15,698,100.00
Included In Blocks	57043 (2010-05-22 18:16:31 + 0 minutes)	Fees	\$ 1,554.11
Confirmations	407774 Confirmations	Fee per byte	4,191.363 sat/B
Relayed by IP	0.0.0.0 (whols)	Estimated BTC Transacted	\$ 15,698,100.00
Visualize	View Tree Chart	Scripts	Show scripts & coinbase

\$15,698,100.00 May 4th 2017

<https://blockchain.info/tx/a1075db55d416d3ca199f55b6084e2115b9345e16c5cf302fc80e9d5fbf5d48d>

BLOCKCHAIN WALLET CHARTS STATS MARKETS API

Transaction View information about a bitcoin transaction

a1075db55d416d3ca199f55b6084e2115b9345e16c5cf302fc80e9d5fbf5d48d

1XPtGDRhN8RFznIWcDobD9KZatrVH4 → 17SkEw2md5avVnyYgJ6RiXUqKNwKxaxFYQ \$ 22,019,900.00

Summary		Inputs and Outputs	
Size	23620 (bytes)	Total Input	\$ 22,022,079.97
Received Time	2010-05-22 18:16:31	Total Output	\$ 22,019,900.00
Included In Blocks	57043 (2010-05-22 18:16:31 + 0 minutes)	Fees	\$ 2,179.97
Confirmations	419247 Confirmations	Fee per byte	4,191.363 sat/B
Relayed by IP	0.0.0.0 (whols)	Estimated BTC Transacted	\$ 22,019,900.00
Visualize	View Tree Chart	Scripts	Show scripts & coinbase

\$22,019,900.00
July 17th, 2017

Not bad for 4 MONTHS "work"

• 2017 •

January							February							March							April						
S	M	T	W	T	F	S	S	M	T	W	T	F	S	S	M	T	W	T	F	S	S	M	T	W	T	F	S
1	2	3	4	5	6	7				1	2	3	4				1	2	3	4							1
8	9	10	11	12	13	14	5	6	7	8	9	10	11	5	6	7	8	9	10	11	2	3	4	5	6	7	8
15	16	17	18	19	20	21	12	13	14	15	16	17	18	12	13	14	15	16	17	18	9	10	11	12	13	14	15
22	23	24	25	26	27	28	19	20	21	22	23	24	25	19	20	21	22	23	24	25	16	17	18	19	20	21	22
29	30	31	26	27	28	26	27	28	29	30	31	24	25	26	27	28	29										

May							June							July							August						
S	M	T	W	T	F	S	S	M	T	W	T	F	S	S	M	T	W	T	F	S	S	M	T	W	T	F	S
1	2	3	4	5	6					1	2	3							1				1	2	3	4	5
7	8	9	10	11	12	13	4	5	6	7	8	9	10	2	3	4	5	6	7	8	6	7	8	9	10	11	12
14	15	16	17	18	19	20	11	12	13	14	15	16	17	9	10	11	12	13	14	15	13	14	15	16	17	18	19
21	22	23	24	25	26	27	18	19	20	21	22	23	24	16	17	18	19	20	21	22	20	21	22	23	24	25	26
28	29	30	31	25	26	27	28	29	30	23	24	25	26	27	28	29	27	28	29	30	31						

September							October							November							December							
S	M	T	W	T	F	S	S	M	T	W	T	F	S	S	M	T	W	T	F	S	S	M	T	W	T	F	S	
				1	2		1	2	3	4	5	6	7				1	2	3	4							1	2
3	4	5	6	7	8	9	8	9	10	11	12	13	14	5	6	7	8	9	10	11	3	4	5	6	7	8	9	
10	11	12	13	14	15	16	15	16	17	18	19	20	21	12	13	14	15	16	17	18	10	11	12	13	14	15	16	
17	18	19	20	21	22	23	22	23	24	25	26	27	28	19	20	21	22	23	24	25	17	18	19	20	21	22	23	
24	25	26	27	28	29	30	29	30	31	26	27	28	29	30	24	25	26	27	28	29	30							

\$10,380,500.00

Do The Math

March 15th – April 10th

\$12,079,400.00
- \$11,639,400.00

= \$440,000.00

March 15th – July 17th

\$22,019,900.00
- \$11,639,400.00

= \$10,380,500.00

<https://blockchain.info/tx/a1075db55d416d3ca199f55b6084e2115b9345e16c5cf302fc80e9d5fbf5d48d>

BLOCKCHAIN WALLET CHARTS STATS MARKETS API

Transaction View information about a bitcoin transaction

a1075db55d416d3ca199f55b6084e2115b9345e16c5cf302fc80e9d5fbf5d48d

1XPTgDRhN8RFznIWcddobD9KZatrvH4 → 17SKEw2md5avVnyYg6RiXuQKNwXaxFyQ **\$35,942,000.00**

Summary		Inputs and Outputs	
Size	23620 (bytes)	Total Input	\$ 35,945,558.26
Weight	94480	Total Output	\$ 35,942,000.00
Received Time	2010-05-22 18:16:31	Fees	\$ 3,558.26
Included In Blocks	57043 (2010-05-22 18:16:31 + 0 minutes)	Fee per byte	4,191.363 sat/B
Confirmations	429495 Confirmations	Fee per weight unit	1,047.841 sat/WU
Visualize	View Tree Chart	Estimated BTC Transacted	\$ 35,942,000.00
		Scripts	Show scripts & coinbase

\$35,942,000.00
September 22nd, 2017

Not bad for 6 MONTHS "work"

• 2017 •

January							February							March							April						
S	M	T	W	T	F	S	S	M	T	W	T	F	S	S	M	T	W	T	F	S	S	M	T	W	T	F	S
1	2	3	4	5	6	7				1	2	3	4				1	2	3	4							1
8	9	10	11	12	13	14	5	6	7	8	9	10	11	5	6	7	8	9	10	11	2	3	4	5	6	7	8
15	16	17	18	19	20	21	12	13	14	15	16	17	18	12	13	14	15	16	17	18	9	10	11	12	13	14	15
22	23	24	25	26	27	28	19	20	21	22	23	24	25	19	20	21	22	23	24	25	16	17	18	19	20	21	22
29	30	31	26	27	28	26	27	28	29	30	31	24	25	26	27	28	29										

May							June							July							August						
S	M	T	W	T	F	S	S	M	T	W	T	F	S	S	M	T	W	T	F	S	S	M	T	W	T	F	S
1	2	3	4	5	6				1	2	3						1				1	2	3	4	5		
7	8	9	10	11	12	13	4	5	6	7	8	9	10	2	3	4	5	6	7	8	6	7	8	9	10	11	12
14	15	16	17	18	19	20	11	12	13	14	15	16	17	9	10	11	12	13	14	15	13	14	15	16	17	18	19
21	22	23	24	25	26	27	18	19	20	21	22	23	24	16	17	18	19	20	21	22	20	21	22	23	24	25	26
28	29	30	31	25	26	27	28	29	30	25	26	27	28	29	27	28	29	30	31								

September							October							November							December								
S	M	T	W	T	F	S	S	M	T	W	T	F	S	S	M	T	W	T	F	S	S	M	T	W	T	F	S		
						1	2	1	2	3	4	5	6	7				1	2	3	4							1	2
3	4	5	6	7	8	9	8	9	10	11	12	13	14	5	6	7	8	9	10	11	3	4	5	6	7	8	9		
10	11	12	13	14	15	16	15	16	17	18	19	20	21	12	13	14	15	16	17	18	10	11	12	13	14	15	16		
17	18	19	20	21	22	23	22	23	24	25	26	27	28	19	20	21	22	23	24	25	17	18	19	20	21	22	23		
24	25	26	27	28	29	30	29	30	31	26	27	28	29	30	24	25	26	27	28	29	30								

\$24,302,600.00



New Prediction Puts Bitcoin Price at \$500,000 in 2030

7:30 am April 9, 2017 Gautham Bitcoin News, News



A recent prediction by Jeremy Liew and Peter Smith puts Bitcoin price in 2030 at \$500,000. Read more...



<http://www.newsbtc.com/>

Bitcoin losing value?

13 Japanese Exchanges Agree to Suspend Bitcoin Service on August 1

By *Kevin Helms* - July 18, 2017 👁 67336 🗨 12

SHARE    

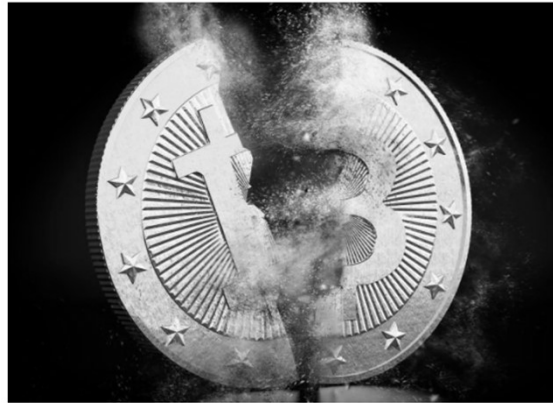

<https://news.bitcoin.com/13-japanese-exchanges-suspend-bitcoin-service-august-1/>

Block chain split

A Bitcoin Beginner's Guide to Surviving the BIP 148 UASF

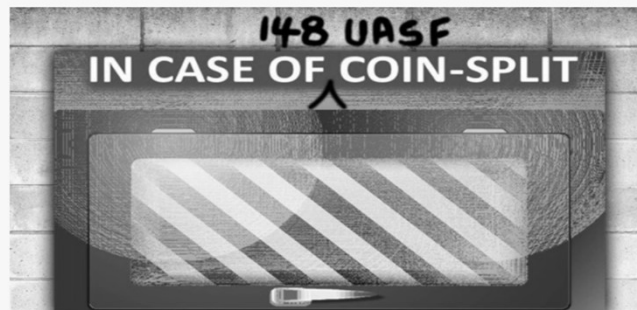

This is a re-write of [A Bitcoin Beginner's Guide to Surviving a Coin-Split](#), specifically addressing issues associated with the upcoming BIP 148 UASF.

<https://bitcoinmagazine.com/articles/bitcoin-beginners-guide-surviving-bip-148-uasf/>

Two blockchains?

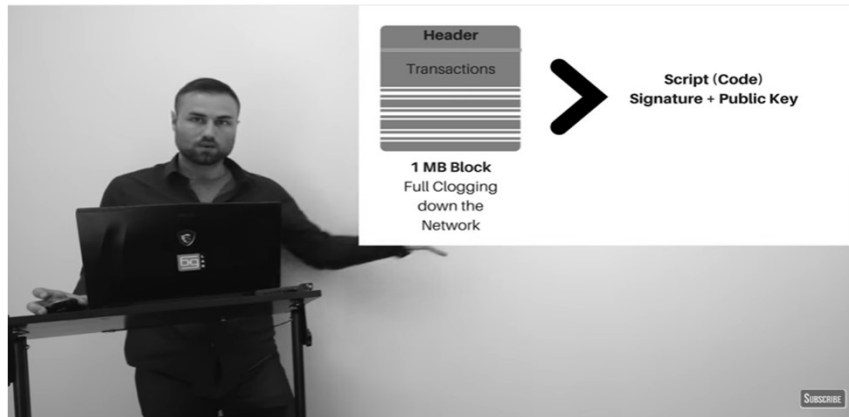

What is Segwit? Explained To A Child



Ameer Rosic

Subscribe 108K

58,355 views

<https://www.youtube.com/watch?v=OFfBRzh9HmU>

Competing cryptocurrency

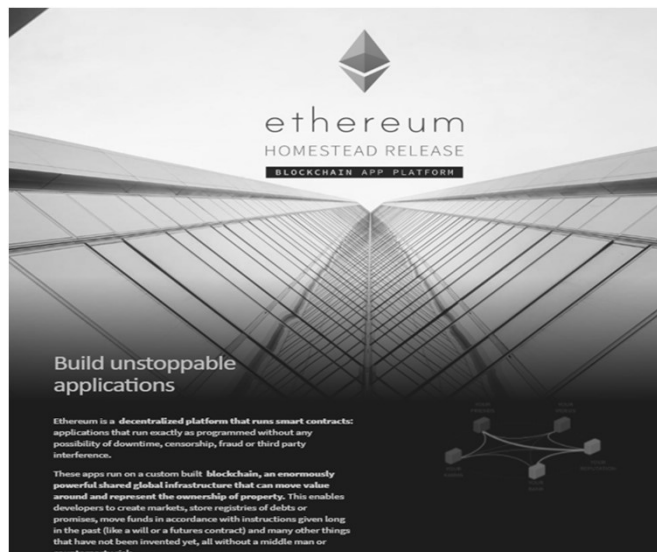

www.ethereum.org

Oops...

QUARTZ

CRYPTO ENTOMOLOGY

A coding error led to \$30 million in ethereum being stolen

The \$30 million heist is the latest embarrassing, and costly, episode caused by an ethereum coding snafu. The offending code had a single missing word, according to one longtime ethereum programmer, Christoph Jentzsch.



<https://qz.com/1034321/ethereum-hack-a-coding-error-led-to-30-million-in-ethereum-being-stolen/>

Bitcoin Cash is born

CNBC HOME U.S. NEWS MARKETS INVESTING TECH MAKE IT VIDEO

New digital currency 'bitcoin cash' rallies nearly 200% following blockchain split

- A new digital currency called "bitcoin cash" was created yesterday by the splitting of the bitcoin blockchain.
- Everyone who held bitcoin before the split was entitled to receive the same number of "bitcoin cash" tokens.
- The price of the new token has rallied nearly 200 percent from around \$214 to \$628.

Luke Graham | @LukeWGraham
Published 8:35 AM ET Wed, 2 Aug 2017 | Updated 9:29 AM ET Wed, 2 Aug 2017

Say hello to bitcoin's new twin: bitcoin cash

Getty Images

CNBC

<https://www.cnbc.com/2017/08/02/bitcoin-cash-rallies-blockchain-split-digital-currency.html>

Very volatile but can be very profitable

Home ▶ News ▶ Crypto ▶ Bitcoin Cash Price Drops by Nearly 12% Overnight

Bitcoin Cash Price Drops by Nearly 12% Overnight

JP Buntinx September 22, 2017 Crypto News



BITCOIN CASH PRICE HEADS TOWARD \$400

This week has been pretty interesting for Bitcoin Cash holders. More specifically, we saw a brief pump earlier in the week which could have pushed the price to US\$550 or more. At that time, it

<https://themerke.com/bitcoin-cash-price-drops-by-nearly-12-overnight/>

<https://www.itjungle.com/2017/04/10/blockchain-link-long-term-ibm-plan/>

THE FOUR HUNDRED

Power Systems & IBM i Insight

BLOCKCHAIN: A LINK IN YOUR LONG TERM IBM I PLAN

April 10, 2017 Dan Burger

In general, the IBM i community gets derogatorily tagged with having minimal tolerance for risk. Having little appetite for risk isn't such a bad thing when the *failure rate* for implementing a new technology – namely blockchain – in a business environment falls just short of a sure bet. Gartner predicts that 90 percent of the enterprise blockchain projects launched in 2016 and the first half of 2017 will crash and burn within two years.

Sounds like the kind of risk anyone would like to avoid. So why should you care about blockchain? No bandwagon recommendations, but some blockchain awareness could come in handy during your next management meeting.

First of all, there's a distinction to be made between generic blockchain and IBM Blockchain. The original idea for blockchain was to provide a framework for the peer-to-peer exchange of digital assets (sometimes referred to as cryptocurrencies), known as Bitcoin. There's no shortage of news, opinions, and confusion about bitcoin, which is an unfortunate distraction to conversations about blockchain and how it can be used in business-to-business exchanges.

ibm.com/blockchain

The screenshot shows the IBM Blockchain website homepage. At the top left, the URL "ibm.com/blockchain" is displayed. The main navigation bar includes the IBM logo, "IBM Blockchain", and a search bar. Below the navigation, the main content area features a large banner with the text "Understand the fundamentals of IBM Blockchain" and a sub-headline: "Blockchain technologies present opportunities for disruptive innovation. It enables global business transactions with less friction and more trust." A button labeled "Download Blockchain for Dummies" is positioned below this text. To the right, there is a graphic of the book cover for "Blockchain for Dummies, IBM Limited Edition" by Manav Gupta. Below the banner, there are two main sections: "IBM Think Academy: Blockchain, how it works" with a play button icon, and "Blockchain 101" with a sub-headline "Gain a deeper understanding of the technology, its use cases and the key considerations for production." A "Download the infographic" button is located below the Blockchain 101 section. At the bottom left, a statistic shows "75%" with a small URL below it. At the bottom right, there is a section titled "What is the difference between Bitcoin and blockchain?" with a network diagram background.

Download a free 51 page book on Blockchain

The image shows the cover of the book "Blockchain for Dummies, IBM Limited Edition" by Manav Gupta. The cover is primarily black and white. At the top, it says "Compliments of" followed by the IBM logo. The title "Blockchain for dummies" is prominently displayed in large white font, with "A Wiley Brand" in smaller text below it. Below the title, it says "IBM Limited Edition". The central graphic features the "Stupid Guy" character, a cartoon man with glasses and a wide-eyed expression, inside a circular frame. To the right of the character, a speech bubble contains the text: "Grasp blockchain fundamentals", "Make blockchain real for business", and "Get started on blockchain". The author's name, "Manav Gupta", is printed at the bottom of the cover.

Blockchain Developer Center developer.ibm.com/blockchain

IBM developerWorks Blockchain Marketplace Charles Guarino

IBM Blockchain Dev Center Home Blog Events Support Why IBM? Develop your blockchain application

Blockchain Developer Center

Explore and accelerate blockchain application development with free tools, tutorials, and community collaboration

Start developing applications on the IBM Blockchain Platform

Meet the new IBM Blockchain Platform
Simplified development, governance, and operation of business networks
 This enterprise-ready blockchain platform makes it easy to activate and manage a secure business network across multiple organizations. Best of all, it's powered by open source technology from Hyperledger Fabric and Hyperledger Composer, paving the way for collaborative application development in your preferred environment.

Stay updated. Get our newsletter.

Learn more about the IBM Blockchain Platform

Blockchain Developer Center developer.ibm.com/blockchain

IBM Code

Everything you need to solve real problems:
 Architecture diagrams, one-click deployment git repos, and pointers to essential docs.

See the code

Latest tutorials

- Enabling parallel Linux operating system deployment over a network on IBM PowerVM
- Building connected cities with new and existing IoT technologies
- Offloading your Informix data in Spark, Part 3: Complex analysis
- Send SMP data directly to the IBM Db2 Analytics Accelerator
- Automate operational business decisions with Weather Data and Business Rules services on Bluemix, Part 1: Get started with a sample weather cancellation service

Latest videos

- Build a cognitive IoT app with Watson IoT Platform, Node-RED, and Data Science Experience
- New developers use mainframe tools
- Build a business network with IBM Blockchain Platform, Live!
- Build your own bot, TobyJnr: Wiring the components together
- Build your own bot, TobyJnr: Setting up your raspberry Pi
- All videos

Get started today

Get up and running quickly with these fundamental technologies:

- Get started with Blockchain
- Get started with Cloud (Bluemix)
- Get started with Cognitive
- Get started with IoT
- Get started with Java

What We'll Cover ...

- Where do you fit in?
- IBM i
- Rational Developer for i (RDi)
- Current events
- Dark Web
- Free Apps?
- Hacking Around
- Wrap-up

Darkweb

Living in the shadows

Hit men, drugs and malicious teens: the darknet is going mainstream

Harriet Taylor | @Harri8t | Thursday, 19 May 2016 | 7:30 AM ET

"You can hire people to hack different things, you can hire people to kill people, which is pretty scary."

-Daniel Smith, Radware security researcher

<http://www.cnn.com/2016/05/18/hit-men-drugs-and-malicious-teens-the-darknet-is-going-mainstream.html>

<https://www.torproject.org>

The screenshot shows the homepage of the Tor Project website. At the top, there is a navigation menu with links for Home, About Tor, Documentation, Press, Blog, and Contact. Below the navigation, there are buttons for Download, Volunteer, and Donate. The main content area features a large banner for "Anonymity Online" with a sub-headline "Protect your privacy. Defend yourself against network surveillance and traffic analysis." and a "Download Tor" button. To the right of the banner is a list of bullet points describing Tor's features. Below the banner, there are sections for "What is Tor?", "Why Anonymity Matters", and "Our Projects". The "Our Projects" section includes links for Tor Browser and Orbot. On the right side, there is a "Recent Blog Posts" section with a list of recent updates and a "Who Uses Tor?" section with sub-sections for Family & Friends, Businesses, and Activists.

Anonymity Online
Protect your privacy. Defend yourself against network surveillance and traffic analysis.

Download Tor

- Tor prevents people from learning your location or browsing habits.
- Tor is for web browsers, instant messaging clients, and more.
- Tor is free and open source for Windows, Mac, Linux/Unix, and Android

What is Tor?
Tor is free software and an open network that helps you defend against traffic analysis, a form of network surveillance that threatens personal freedom and privacy, confidential business activities and relationships, and state security.
[Learn more about Tor >>](#)

Why Anonymity Matters
Tor protects you by bouncing your communications around a distributed network of relays run by volunteers all around the world: it prevents somebody watching your Internet connection from learning what sites you visit, and it prevents the sites you visit from learning your physical location.
[Get Involved with Tor >>](#)

Our Projects

- Tor Browser**
Tor Browser contains everything you need to safely browse the Internet.
- Orbot**
Tor for Google Android devices.

Recent Blog Posts

- [Tor Browser 7.0a2-hardened is released](#)
Wed, 08 Mar 2017 Posted by: bokim
- [Tor Browser 7.0a2 is released](#)
Wed, 08 Mar 2017 Posted by: bokim
- [Tor Browser 6.5.1 is released](#)
Tue, 07 Mar 2017 Posted by: bokim
- [Atlas Recent Improvements](#)
Mon, 06 Mar 2017 Posted by: iit
- [Tor Messenger 0.4.0b1 is released](#)
Mon, 06 Mar 2017 Posted by: sukhbir

[View all blog posts >](#)

Who Uses Tor?

- Family & Friends**
People like you and your family use Tor to protect themselves, their children, and their dignity while using the Internet.
- Businesses**
Businesses use Tor to research competition, keep business strategies confidential, and facilitate internal accountability.
- Activists**
Activists use Tor to anonymously report abuses from danger zones.
[Whistleblowers use Tor to safely report](#)

<https://www.washingtonpost.com/news/the-switch/wp/2016/09/07/hacked-dropbox-data-of-68-million-users-is-now-for-sale-on-the-dark-web>

The Switch

Hacked Dropbox login data of 68 million users is now for sale on the dark Web

By Karen Turner September 7, 2016



Dropbox, a file-sharing app, has recently been under scrutiny after more than 70 million of its users' credentials were hacked. (Jaap Arriens/Nurphoto via Getty Images)

Email and password data for more than 68 million Dropbox users is for sale in the darknet marketplace.

The data set, which is from a 2012 breach, includes users' email addresses as well as obscured passwords. The nearly 5 gigabytes of data represents one of the larger user credential leaks in recent years. Its price is reportedly being set at two bitcoins, the equivalent of about \$1,141, by a data trafficker on the darknet website TheRealDeal. There are no reports that the data set has been successfully sold yet.

Cryptolocker

Cryptolocker 2.0

Your personal files are encrypted



Your files will be lost without payment on:
11/24/2013 3:16:34 PM

Info

Your **important files were encrypted** on this computer: photos, videos, documents, etc. You can verify this by click on see files and try to open them.

Encryption was produced using **unique** public key RSA-4096 generated for this computer. To decrypt files, you need to obtain **private** key.

The single copy of the private key, which will allow you to decrypt the files, is located on a secret server on the Internet; **the server will destroy the key within 72 hours after encryption completed**. After that, nobody and never will be able to restore files.]

To retrieve the private key, you need to pay 0.5 bitcoins.

Click **proceed to payment** to obtain private key.

Any attempt to remove or damage this software will lead to immediate private key destruction by server.

See files << Back Proceed to payment >>

Locky- <https://malwaretips.com/blogs/remove-locky-virus/>

We present a special software - *Locky Decrypter* - which allows to decrypt and return control to all your encrypted files.

How to buy Locky decrypter?

1. You can make a payment with BitCoins, there are many methods to get them.



2. You should register BitCoin wallet ([simplest online wallet](#) OR [some other methods of creating wallet](#))
3. Purchasing Bitcoins - Although it's not yet easy to buy bitcoins, it's getting simpler every day.

Here are our recommendations:

- [LocalBitcoins.com \(WU\)](#) - Buy Bitcoins with Western Union
- [Coincafe.com](#) - Recommended for fast, simple service.

Payment Methods: Western Union, Bank of America, Cash by FedEx, Moneygram, Money Order. In NYC: Bitcoin ATM, In Person

<https://www.bleepingcomputer.com/news/security/ransomware-locks-down-public-libraries-at-all-locations-across-saint-louis/>

Ransomware Locks Down Public Libraries at All Locations Across Saint Louis

By Catalin Cimpanu

January 20, 2017 12:40 PM 4



The Saint Louis Public Library (SLPL) announced that ransomware had hit all computers at all their branches across the city forcing the institution to halt all operations for the time being.

Over 700 computers at all of SLPL's 16 branches have been hit. According to library spokesperson Jen Hatton, SLPL doesn't intend to pay the ransom, which is around \$35,000, about \$50 per infected PC.

Instead, library technicians plan to wipe and reinstall all computers from the ground up, an operation that might take a while, several local news outlets have reported [1, 2, 3, 4].

<https://www.bleepingcomputer.com/news/security/cerber-ransomware-version-6-gets-anti-vm-and-anti-sandboxing-features/>

Cerber Ransomware Version 6 Gets Anti-Vm and Anti-Sandboxing Features

By Catalin Cimpanu

May 3, 2017 03:20 PM 0

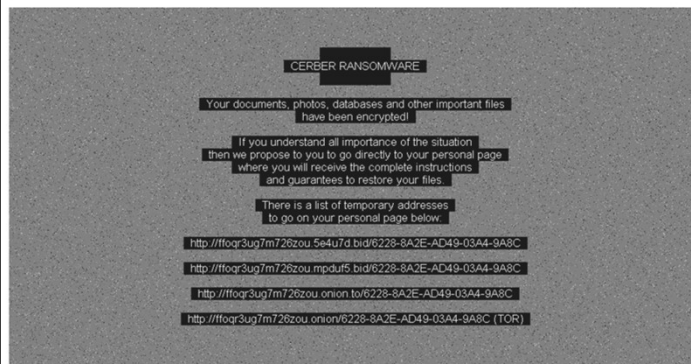

Security researchers have spotted version 6 of the Cerber ransomware, and this new edition continues to add new features, heightening the overall complexity this ransomware family has been showing.

First detected at the end of March, version 6 comes with new distribution vectors, a revised encryption routine, and anti-sandbox and anti-AV defensive features.

GX40



AngryKite

Warning



WARNING: SYSTEM MAY HAVE FOUND
anonymous encryption on your computer. You would not be able to
access the files on your computer

Your System May have Found (2) Malicious Viruses *Rootkit.Encrypt & Trojan.Spyware*

Your Personal & Fincancial information **MAY NOT BE SAFE**

**Your system has encryption ransomware
which may permanently encrypt your data**

Please call immediately to avoid further damage Your UID
Toll free 1-855-545-6800 **734784**

DeathNote Hackers



GX40



Fluffy-Tar

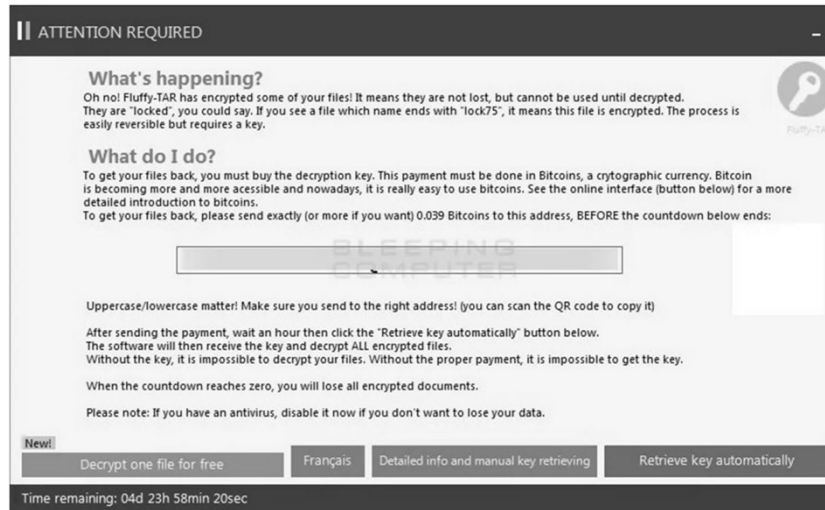

Bleeping Computer's "This week in Ransomware"

BLEEPINGCOMPUTER

Multiple Spam Waves Detected Pushing New Locky Ransomware

Version

Version	Email Subject	Attachment	Download URI	Config
1 st Wave	Status of Invoice	{8-alphanumeric value}-{2-numeric value}.7z (e.g. A2173164-48.7z)	/87thuh3gFDGS	affiliid: 3 URI: /imageLoad.cgi C&C: 91.191.284.158, 195.123.218.226 *online/offline encryption
2 nd Wave	Message from km_c224e	{YYYYDDMM}_{11 numeric value}.7z (e.g. 20171809_60412473780.7z)	/DKndFG72	affiliid: 3 URI: <none> C&C: <none> *offline encryption
3 rd Wave	HERBALIFE Order Number: {10 alphanumeric value} (e.g. HERBALIFE Order Number: 6N01005925)	{10 alphanumeric value}_1.7z (e.g. 6N01005925_1.7z)	/JGHIdb03m	affiliid: 3 URI: <none> C&C: <none> *offline encryption
4 th Wave	Emalling - {11 numeric value} (e.g. Emalling - 10008008711)	{11 numeric value}.7z (e.g. 10008008711.7z)	/y873Pn3iur	affiliid: 3 URI: <none> C&C: <none> *offline encryption
5 th Wave	Status of Invoice {8-alphanumeric value}-{2-numeric value} (e.g. Status of Invoice A2170513-10) Your Payment # {4 numeric value} (e.g. Your Payment # 5955)	{8-alphanumeric value}-{2-numeric value}.rar (e.g. A2170513-10.rar) {4 numeric value}_Payment.7z (e.g. 5955_Payment.7z)	/RS4tNR7	affiliid: 3 URI: <none> C&C: <none> *offline encryption
6 th Wave	New voice message {numeric value} in mailbox {numeric value} from "{numeric value}" <{numeric value}> (e.g. New voice message 15225014194 in mailbox 152250141941 from "15225014194" <9061038221>)	msg{4 numeric value}.7z (e.g. msg0591.7z)	/shgTxc	affiliid: 3 URI: <none> C&C: <none> *offline encryption

<https://www.bleepingcomputer.com/news/security/multiple-spam-waves-detected-pushing-new-locky-ransomware-version>

PadCrypts TOR Payment Site

The screenshot shows a web browser window displaying the PadCrypts TOR Payment Site. The page has a navigation menu with links for Home, Purchase Software, FAQ, and Reviews. A 'LOGOUT' link is visible in the top right corner. The main content area is divided into several sections:

- Information:** A notice stating "File recovery will become impossible soon" and "Time left: ...".
- Contact us:** A form with a text input field and a "Send" button.
- Public Reviews:** A section titled "Public Reviews" with a sub-header "Share your experience". It contains several user testimonials, each with a profile picture and a checkmark indicating a verified review. The reviews include:
 - A review from 28/03/2017 stating "We've added a review system."
 - A review from HUNGB19 stating "de me pay for my files, and now you want me to post about my expe..."
 - A review from HPA10 stating "Although I didn't expect to wake up to ransomware, this experience has been a wake up call for me to change my browsing habits and to backup my files on a regular basis. It's strange to admit the support I was given was top notch. The admins have been responding to my messages amazingly fast and even provided me with a discount. I'm glad everything's sorted and my files were restored."
 - A review from OFFICE stating "I some how got hit on 2 computers. I purchased the recovery utility but it only worked on one of my machines?... Not happy at all"
 - A review from PO2 stating "all files working thanks"
 - A review from NEIL-HP stating "I believe I hi... I get MY OWN files back!!!!!!!"
 - A review from IAN_LAPTOP stating "It's quite low to extort money from innocent people and I'm sure this service you're running is illegal."

RaaS

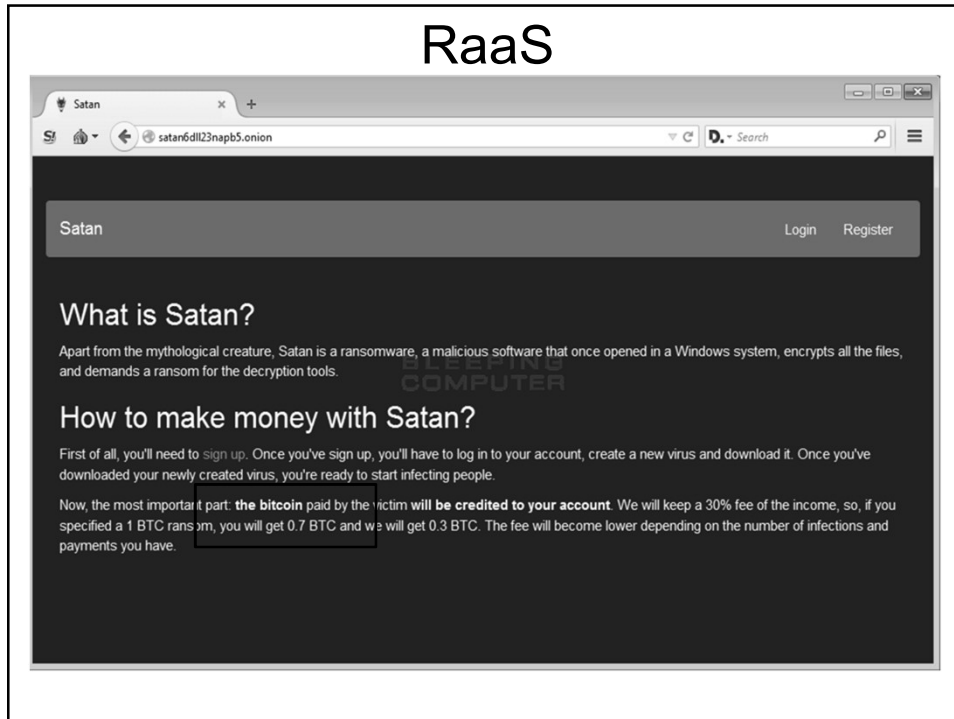

<https://www.bleepingcomputer.com/news/security/new-satan-ransomware-available-through-a-ransomware-as-a-service/>

Payback!!!

The screenshot shows the homepage of Information Security Newspaper. The main article is titled "DARK WEB HOSTING SERVICE HACKED, SOME DATA WAS STOLEN" and is dated July 10, 2017. The article text includes: "Deep Hosting — a Dark Web hosting service — admitted yesterday to suffering a major security incident during which 'some sites have been exported.'" and "The hack took place on Saturday afternoon and was carried out by a hacker calling himself Dhostpwned, the name he used when he spoke with Bleeping Computer earlier today." A sub-headline reads "HACKER USED PHP SHELL TO TAKE OVER HOSTING PROVIDER". The article continues: "According to a wiki page published by the Deep Hosting team, the hack took place after the hacker registered a shared hosting account on their service, and used it to upload two shells on their servers, one written in PHP and one in Perl." and "A Deep Hosting investigation into the events that preceded the hack showed that the attacker was not able to execute the Perl shell, but the PHP version worked just fine." A quote from the article states: "A large part of the PHP shell is unusable since a certain number of functions are blocked on the shared servers but one function was not blocked," Deep Hosting wrote in a wiki page detailing the security incident. "The attacker was able to access the server and execute a commands [sic] with limited rights." The article concludes: "According to a timeline of their investigation — embedded below — it took the Deep Hosting almost a full day to understand what really happened, detect the point of intrusion, and change FTP and SQL password for all user accounts." Below the text is a screenshot of a browser window showing a "Major Security Vulnerability" alert.

Fighting fire with fire

The screenshot shows an article on SecurityIntelligence.com. The article is titled "Wimbledon 2017: Manicured Lawns, Ivy-Covered Buildings, Tennis Whites and Cyberattacks" and is dated July 19, 2017. The author is Johnathan Van Houten. The article text includes: "Another Wimbledon has come and gone. To the victors, the accolades and the trophies - Roger Federer's eighth win and Garbine Muguruza's first. For the IBM team located in the media center's ground floor at SW19, the fortnight concludes with an opportunity to break from the constant vigilance ensuring the availability of Wimbledon.com and the integrity of the data consumed." and "I spent 15 English summers abroad in that basement, staring at screens, looking for cracks and garnering a love for English tea that consumes me to this day. While, sadly, I was unable to venture across the pond for this year's tournament, our on-site team did have Watson for Cyber Security to assist them in protecting the pinnacle of tennis achievement." The article features a photograph of a tennis racket and a plate of food.

<https://securityintelligence.com/news/wimbledon-2017-manicured-lawns-ivy-covered-buildings-tennis-whites-and-cyberattacks/>

Darkweb protection – well that didn't take long



Dark Web Monitoring?

What Is Dark Web Monitoring?

by Susan Henson August 28, 2017

Dark web monitoring, also known as cyber monitoring, is an identity theft prevention product that enables you to monitor your identity information on the dark web, and receive notifications if your information is found online. The dark web, described in this article as the underbelly of the internet, is a shrouded area of the internet, hidden from search engines and only accessible with a special web browser. It also masks IP addresses, which essentially allows fraudsters to operate undetected to commit crimes, including identity theft.

What Does Experian Offer to Monitor My Identity on the Dark Web?

Experian's IdentityWorks Premium includes Dark Web Surveillance for comprehensive dark web monitoring to protect you from the financial and reputational harm that can result from identity theft.

Dark Web Scan

Consumer Small Business Business About Experian Consumer Support Credit Advice Global Sites

experian. Reports & Scores Identity Theft Protection Credit Cards & Loans Support Education Sign In

Protecting your identity starts now.

Take the first step with a FREE Dark Web Email Scan.

Enter email here Start Scan

By clicking Start Scan: I accept and agree to your [Terms of Use Agreement](#), as well as acknowledge receipt of your [Privacy Policy](#) and [Ad Targeting Policy](#). I understand that by requesting this Dark Web Scan that I am consenting to the scan, providing you with my own valid e-mail address, and am a United States resident. I also understand that by submitting my e-mail address on this site that you may use my e-mail address to contact me about your Experian IdentityWorksSM product, or other products that may be of interest to me.

@ Enter a valid email address in the field above. > Check your email for a secure link to your Dark Web report. > View your results on our secure site.

<https://www.experian.com/consumer-products/free-dark-web-email-scan.html>

Do you accept these terms?

By clicking Start Scan: I accept and agree to your [Terms of Use Agreement](#), as well as acknowledge receipt of your [Privacy Policy](#) and [Ad Targeting Policy](#). I understand that by requesting this Dark Web Scan that I am consenting to the scan, providing you with my own valid e-mail address, and am a United States resident. I also understand that by submitting my e-mail address on this site that you may use my e-mail address to contact me about your Experian IdentityWorksSM product, or other products that may be of interest to me.

Do you accept these terms?

Terms of Use Agreement

Revised August 17, 2017

(Please note that our Terms of Use Agreement is also referred to as the "Terms and Conditions")

OVERVIEW AND ACCEPTANCE OF TERMS

You agree that by creating an account with ECS (as defined below), or accessing or using our Services (as defined below), website(s) (such as this website, <https://usa.experian.com>, or any affiliated website (including, but not limited to, Experian.com, FreeCreditReport.com, FreeCreditScore.com, CreditReport.com, CreditCheckTotal.com, CreditScore.com, usa.experian.com, and experian.experiandirect.com)), or mobile application(s) (such as the Experian app), as well as any content provided or accessible in connection with the website(s) or mobile application(s), including information, user interfaces, source code, reports, images, products, services, and data (each website and mobile application referred to herein as a "Website," and collectively, as "Websites"), you represent to ECS that you have read, understood, and expressly consent and agree to be bound by this Terms of Use Agreement, and the terms, conditions, and notices contained or referenced herein ("Agreement") whether you are a "Visitor" (which means that you simply browse or access a Website), or a "Customer" (which means that you have created an account with ECS, or enrolled or registered with a Website, or are accessing or using a Service).

At Customer's election, Customer may, from time to time, request to receive, and ECS may provide, free services or services subject to a fee, whether a recurring fee or a one-time transactional fee (each a "Service"), and Customer's receipt and use of such Services shall, at all times, be subject to this Agreement. The term "Service" includes, but is not limited to, the provision of any of our products and services, including credit reports(s), credit risk score(s), credit monitoring, credit score monitoring and credit score tracking (including all the data and information contained therein), the receipt of any alerts notifying you of changes to the information contained in your credit report(s), regardless of the manner in which you receive the Services, whether by email or mail, through a website or mobile application, by telephone, or through any other mechanism by which a Service is delivered or provided to you. The term "you" or "User" refers to a Visitor or a Customer. For purposes of this Agreement, the terms "we," "us" or "ECS" refer to Experian Consumer Services, Inc., an Experian company (also known as Experian Consumer Services), and referred to as "Experian" on the Websites, its predecessors in interest, successors and assigns, and any of its third party service providers (including, without limitation, cloud service providers) who ECS uses in connection with the provision of the Services to you. If you are a Visitor and do not wish to be bound by this Agreement, you should immediately cease accessing and using the Websites. Notwithstanding the immediate preceding sentence, if you are a Visitor and continue to access and use a Website, by virtue of your continued access and/or use of the Website, you are indicating your acceptance of this Agreement and agreement to be bound by the terms and conditions contained herein. If you wish to be bound by the terms and conditions of the Services, you will be accepted as a Customer.

For the avoidance of doubt, this Agreement expressly applies to: (a) your access to and use of the Websites; (b) any and all transactions between you and ECS through the Websites, including for the provision of any Services or of any credit, personal, financial or other information delivered as part of or in conjunction with free Services or paid Services, including any such information that may be archived to the extent made available on the Websites, such as (i) for your purchase of non-membership based Services such as the 3 Bureau Credit Report and FICO Score, the FICO Industry or other Base FICO Score and/or an Experian Credit Report and FICO Score, (ii) enrollment and use of free Services (such as EXPERIAN CREDITWORKS-Basic), and/or enrollment, purchase and use of membership based Services (such as EXPERIAN CREDITWORKS-Premium, Experian IdentityWorks, or Experian Credit Tracker); and (iii) your access to and use of calculators, credit resources, text, pictures, graphics, logos, button items, icons, images, works of authorship and other information and all revisions, modifications, and enhancements thereto contained in the Websites.

You may not browse the Websites, or create an account or register with ECS, or use or enroll in any Services, and you may not accept this Agreement, if you are not of a legal age to form a binding contract with ECS. If you accept this Agreement, you represent that you have the capacity to be bound by it. Before you continue, you should print or save a local copy of this Agreement for your records.

THE SERVICES AND WEBSITES ARE SUBJECT TO ALL TERMS AND CONDITIONS CONTAINED HEREIN AND ALL APPLICABLE LAWS AND REGULATIONS. PLEASE READ THIS AGREEMENT CAREFULLY. YOUR ACCEPTANCE OF ORDER OF USE OF, AND/OR ACCESS TO, THE SERVICES AND WEBSITES CONSTITUTES YOUR AGREEMENT TO ABIDE BY EACH OF THE TERMS AND CONDITIONS SET FORTH HEREIN. IF YOU DO NOT AGREE WITH ANY OF THESE TERMS OR CONDITIONS, DO NOT USE, ACCESS OR ORDER ANY SERVICE OR ACCESS OR USE THE WEBSITES. IF YOU HAVE ALREADY BEGUN ACCESSING OR USING THE SERVICES AND/OR WEBSITES AND DO NOT AGREE TO BE BOUND BY THIS AGREEMENT, IMMEDIATELY CEASE USING THE SERVICE OR WEBSITE AND/OR DISCARD ANY INFORMATION OR PRODUCTS YOU RECEIVED VIA ANY SERVICE OR WEBSITE (TO THE EXTENT APPLICABLE), AND CALL CUSTOMER CARE AT 1-855-862-6943 TO CANCEL YOUR ACCOUNT WITH ECS. NOTE, YOU MAY ALSO BE ABLE TO DEACTIVATE YOUR PAID SERVICE AND RETAIN YOUR ACCOUNT WITH ECS ONLINE, AS AND TO THE EXTENT EXPLAINED IN FURTHER DETAIL, BELOW.

PERMISSIBLE PURPOSE AND CONSENTS

You understand and agree that, by establishing an account with ECS, or submitting your order or enrolling for any Service (including an order for a Service that includes enrollment of your minor child in such Service), you have provided "written instructions" in accordance with the Fair Credit Reporting Act, as amended ("FCRA"), for ECS, and its service provider, CSIDENTITY Corporation, an Experian company ("CSID"), to obtain your credit report and/or credit score(s) (or the credit report or credit score(s)) of any minor children whom you have enrolled in a Service) on a recurring basis to provide them to you while you have an account with ECS, and

Done yet?

Terms of Use Agreement

Revised August 17, 2017

(Please note that our Terms of Use Agreement is also referred to as the "Terms and Conditions")

OVERVIEW AND ACCEPTANCE OF TERMS

You agree that by creating an account with ECS (as defined below), or accessing or using our Services (as defined below), website(s) (such as this website, <https://usa.experian.com>, or any affiliated website (including, but not limited to, Experian.com, FreeCreditReport.com, FreeCreditScore.com, CreditReport.com, CreditCheckTotal.com, CreditScore.com, usa.experian.com, and experian.experiandirect.com)), or mobile application(s) (such as the Experian app), as well as any content provided or accessible in connection with the website(s) or mobile application(s), including information, user interfaces, source code, reports, images, products, services, and data (each website and mobile application referred to herein as a "Website," and collectively, as "Websites"), you represent to ECS that you have read, understood, and expressly consent and agree to be bound by this Terms of Use Agreement, and the terms, conditions, and notices contained or referenced herein ("Agreement") whether you are a "Visitor" (which means that you simply browse or access a Website), or a "Customer" (which means that you have created an account with ECS, or enrolled or registered with a Website, or are accessing or using a Service).

At Customer's election, Customer may, from time to time, request to receive, and ECS may provide, free services or services subject to a fee, whether a recurring fee or a one-time transactional fee (each a "Service"), and Customer's receipt and use of such Services shall, at all times, be subject to this Agreement. The term "Service" includes, but is not limited to, the provision of any of our products and services, including credit reports(s), credit risk score(s), credit monitoring, credit score monitoring and credit score tracking (including all the data and information contained therein), the receipt of any alerts notifying you of changes to the information contained in your credit report(s), regardless of the manner in which you receive the Services, whether by email or mail, through a website or mobile application, by telephone, or through any other mechanism by which a Service is delivered or provided to you. The term "you" or "User" refers to a Visitor or a Customer. For purposes of this Agreement, the terms "we," "us" or "ECS" refer to Experian Consumer Services, Inc., an Experian company (also known as Experian Consumer Services), and referred to as "Experian" on the Websites, its predecessors in interest, successors and assigns, and any of its third party service providers (including, without limitation, cloud service providers) who ECS uses in connection with the provision of the Services to you. If you are a Visitor and do not wish to be bound by this Agreement, you should immediately cease accessing and using the Websites. Notwithstanding the immediate preceding sentence, if you are a Visitor and continue to access and use a Website, by virtue of your continued access and/or use of the Website, you are indicating your acceptance of this Agreement and agreement to be bound by the terms and conditions contained herein. If you wish to be bound by the terms and conditions of the Services, you will be accepted as a Customer.

For the avoidance of doubt, this Agreement expressly applies to: (a) your access to and use of the Websites; (b) any and all transactions between you and ECS through the Websites, including for the provision of any Services or of any credit, personal, financial or other information delivered as part of or in conjunction with free Services or paid Services, including any such information that may be archived to the extent made available on the Websites, such as (i) for your purchase of non-membership based Services such as the 3 Bureau Credit Report and FICO Score, the FICO Industry or other Base FICO Score and/or an Experian Credit Report and FICO Score, (ii) enrollment and use of free Services (such as EXPERIAN CREDITWORKS-Basic), and/or enrollment, purchase and use of membership based Services (such as EXPERIAN CREDITWORKS-Premium, Experian IdentityWorks, or Experian Credit Tracker); and (iii) your access to and use of calculators, credit resources, text, pictures, graphics, logos, button items, icons, images, works of authorship and other information and all revisions, modifications, and enhancements thereto contained in the Websites.

You may not browse the Websites, or create an account or register with ECS, or use or enroll in any Services, and you may not accept this Agreement, if you are not of a legal age to form a binding contract with ECS. If you accept this Agreement, you represent that you have the capacity to be bound by it. Before you continue, you should print or save a local copy of this Agreement for your records.

THE SERVICES AND WEBSITES ARE SUBJECT TO ALL TERMS AND CONDITIONS CONTAINED HEREIN AND ALL APPLICABLE LAWS AND REGULATIONS. PLEASE READ THIS AGREEMENT CAREFULLY. YOUR ACCEPTANCE OF ORDER OF USE OF, AND/OR ACCESS TO, THE SERVICES AND WEBSITES CONSTITUTES YOUR AGREEMENT TO ABIDE BY EACH OF THE TERMS AND CONDITIONS SET FORTH HEREIN. IF YOU DO NOT AGREE WITH ANY OF THESE TERMS OR CONDITIONS, DO NOT USE, ACCESS OR ORDER ANY SERVICE OR ACCESS OR USE THE WEBSITES. IF YOU HAVE ALREADY BEGUN ACCESSING OR USING THE SERVICES AND/OR WEBSITES AND DO NOT AGREE TO BE BOUND BY THIS AGREEMENT, IMMEDIATELY CEASE USING THE SERVICE OR WEBSITE AND/OR DISCARD ANY INFORMATION OR PRODUCTS YOU RECEIVED VIA ANY SERVICE OR WEBSITE (TO THE EXTENT APPLICABLE), AND CALL CUSTOMER CARE AT 1-855-862-6943 TO CANCEL YOUR ACCOUNT WITH ECS. NOTE, YOU MAY ALSO BE ABLE TO DEACTIVATE YOUR PAID SERVICE AND RETAIN YOUR ACCOUNT WITH ECS ONLINE, AS AND TO THE EXTENT EXPLAINED IN FURTHER DETAIL, BELOW.

PERMISSIBLE PURPOSE AND CONSENTS

You understand and agree that, by establishing an account with ECS, or submitting your order or enrolling for any Service (including an order for a Service that includes enrollment of your minor child in such Service), you have provided "written instructions" in accordance with the Fair Credit Reporting Act, as amended ("FCRA"), for ECS, and its service provider, CSIDENTITY Corporation, an Experian company ("CSID"), to obtain your credit report and/or credit score(s) (or the credit report or credit score(s)) of any minor children whom you have enrolled in a Service) on a recurring basis to provide them to you while you have an account with ECS, and

PLEASE READ THIS CAREFULLY BEFORE USING OUR SERVICES.

By using our Services, you agree to be bound by the following terms and conditions. These terms and conditions apply to all users of our Services, whether you are a Customer or a Visitor. If you are a Customer, you agree to be bound by these terms and conditions in addition to the terms and conditions of the Services you use. If you are a Visitor, you agree to be bound by these terms and conditions in addition to the terms and conditions of the Websites you use. If you are a minor, you must have the consent of your parent or guardian to use our Services. If you are a minor, you agree to be bound by these terms and conditions in addition to the terms and conditions of the Services you use. If you are a minor, you agree to be bound by these terms and conditions in addition to the terms and conditions of the Websites you use. If you are a minor, you agree to be bound by these terms and conditions in addition to the terms and conditions of the Services you use. If you are a minor, you agree to be bound by these terms and conditions in addition to the terms and conditions of the Websites you use.

GENERAL DESCRIPTION OF SERVICES

The Services and Websites are provided to you by ECS. The Services include credit reports, credit scores, credit monitoring, credit score monitoring, and credit score tracking. The Websites include the Experian app, the Experian website, and other affiliated websites. The Services and Websites are provided to you by ECS. The Services include credit reports, credit scores, credit monitoring, credit score monitoring, and credit score tracking. The Websites include the Experian app, the Experian website, and other affiliated websites.

ACCOUNT WITH ECS, USE OF THE SERVICES

You agree that by creating an account with ECS, you agree to be bound by these terms and conditions. You agree to provide accurate and complete information when you create an account with ECS. You agree to keep your account information up to date. You agree to use our Services in accordance with these terms and conditions. You agree to not use our Services for any illegal or prohibited purpose. You agree to not use our Services to harass, defame, or otherwise harm any person. You agree to not use our Services to violate any applicable laws or regulations. You agree to not use our Services to violate any applicable terms of service. You agree to not use our Services to violate any applicable policies. You agree to not use our Services to violate any applicable standards. You agree to not use our Services to violate any applicable codes of conduct. You agree to not use our Services to violate any applicable ethics. You agree to not use our Services to violate any applicable principles. You agree to not use our Services to violate any applicable norms. You agree to not use our Services to violate any applicable customs. You agree to not use our Services to violate any applicable mores. You agree to not use our Services to violate any applicable traditions. You agree to not use our Services to violate any applicable customs. You agree to not use our Services to violate any applicable mores. You agree to not use our Services to violate any applicable traditions.

FCRA DISCLOSURES

By using our Services, you agree to be bound by the following terms and conditions. These terms and conditions apply to all users of our Services, whether you are a Customer or a Visitor. If you are a Customer, you agree to be bound by these terms and conditions in addition to the terms and conditions of the Services you use. If you are a Visitor, you agree to be bound by these terms and conditions in addition to the terms and conditions of the Websites you use. If you are a minor, you must have the consent of your parent or guardian to use our Services. If you are a minor, you agree to be bound by these terms and conditions in addition to the terms and conditions of the Services you use. If you are a minor, you agree to be bound by these terms and conditions in addition to the terms and conditions of the Websites you use. If you are a minor, you agree to be bound by these terms and conditions in addition to the terms and conditions of the Services you use. If you are a minor, you agree to be bound by these terms and conditions in addition to the terms and conditions of the Websites you use.

How about now?

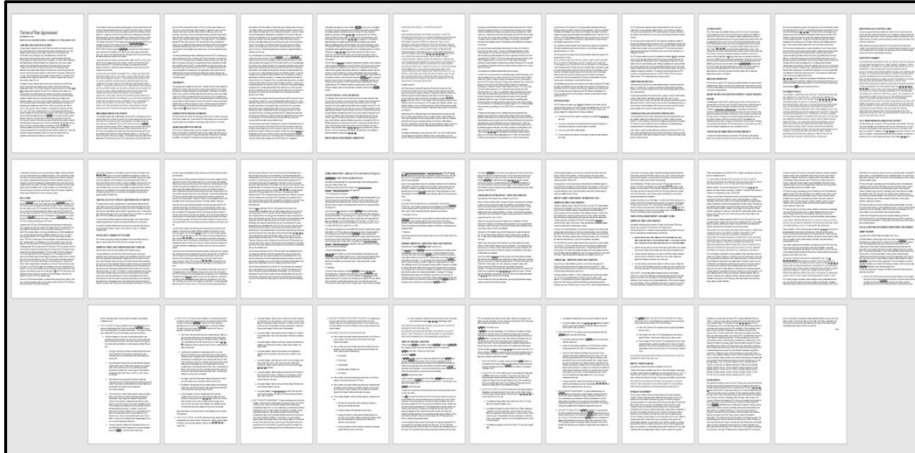

What We'll Cover ...

- Where do you fit in?
- IBM i
- Rational Developer for i (RDi)
- Current events
- Dark Web
- Free Apps?
- Hacking Around
- Wrap-up

Free Apps?



CBS NEWS July 4, 2016, 7:37 AM

Beware downloading some apps or risk "being spied on"

"You're gonna lose your identity.
You're gonna wonder why there was a transaction."

"You think an alarm clock needs all those permissions?
This to me is not a safe alarm clock."

"The flashlight app spies on your camera and noticed the (online banking) check and grabbed a copy of it."

White noise



Updates? Bug fixes?

Updates Update All

Available Updates



Bed Time Fan - Whit...
Version 1.42, 16.3 MB
Aug 9, 2017

UPDATE

Thank you for using Bed Time Fan! To make our app better for you, we bring you regular updates.

- Updated icon
- Bug fixes

What We'll Cover ...

- Where do you fit in?
- IBM i
- Rational Developer for i (RDi)
- Current events
- Dark Web
- Free Apps?
- **Hacking Around**
- Wrap-up

You'd think here people would be smart



Is yours on the list?

123456	1234567	666666	3rjs1la7qe
123456789	password	18atcskd2w	google
qwerty	123123	7777777	1q2w3e4r5t
12345678	987654321	1q2w3e4r	123qwe
111111	qwertyuiop	654321	zxcvbnm
1234567890	mynoob	5555555	1q2w3e
123321			

Use a password manager?



A nice refrigerator to keep your food fresh



Frigidaire - 22 Cu. Ft. Refrigerator - Stainless steel
Model: FFSS2315TS- | SKU: 5900130

Touch sensitive controls; 2 cantilevered shelves; 2 Store-More shelves; 2 clear drawers; 2 clear Gallon Door Bins; 2 humidity controlled drawers; deli drawer; dairy compartment; 3 fixed freezer shelves; 2 wire freezer shelves; 4 white freezer door bins; plastic freezer basket; LED interior lighting

Add to Compare

☆☆☆☆☆ Not yet reviewed

 **Delivery: FREE**
As soon as Wed, Sep 27
Delivery with installation available as soon as Thu, Sep 28.

PRICE MATCH GUARANTEE

\$989.99

Local Rebates for 11801
No rebates available

- Free Delivery on Orders \$399 and Up

A nice WIFI refrigerator to keep your food fresh



Add to Compare

Samsung - Family Hub 2.0 22.0 Cu. Ft. 4-Door Flex French Door Counter-Depth Refrigerator - Black Stainless Steel

Model: RF22M9581SG | SKU: 5728814

Ice/Water dispenser; FlexZone™; Triple Cooling system; High-Efficiency LED lighting; Wine Rack; Fingerprint-Proof Coating; Counter-Depth design

★★★★☆ 4.5 (49)

 **Delivery: FREE**
As soon as Wed, Sep 27
Delivery with installation available as soon as Thu, Sep 28.

PRICE MATCH GUARANTEE

\$3,999.99

Included Free: 1 item



Local Rebates for 11801
Get \$150 from 2 rebates

- Free Delivery on Orders \$399 and Up
- Free Samsung Connect Home Wi-Fi System
- 10% Off Samsung Appliance Package

A nice WIFI refrigerator to keep your food fresh

INSTEAD OF BUYING A WHOLE NEW FRIDGE, YOU CAN STICK THIS CAMERA INSIDE YOURS

By Jenny McGrath — Posted on January 6, 2016 10:55 am

f 85  + Subscribe  Share







Cracked ice?



<http://www.npr.org/sections/alltechconsidered/2014/01/16/263111193/refrigerator-or-hacked-reveals-internet-of-things-security-gaps>

A weighty issue

Emergent Tech › Internet of Things

It's 2016 and now your internet-connected bathroom scales can be hacked

Weight to go, Internet of S***

By Shaun Nichols in San Francisco 29 Apr 2016 at 20:05 64 SHARE



Owners of Fitbit's Aria internet-connected smart scales are being advised to install a firmware patch following the discovery of critical security flaws.

<https://www.bleepingcomputer.com/news/security/attackers-can-use-hvac-systems-to-control-malware-on-air-gapped-networks/>

Toast of the IOT

First ever IoT device- “The Internet Toaster”

AUGUST 5, 2016 by SRISHTI DEORAS



iPlayer Toaster with a 7-inch touchscreen
unveiled by BBC in 2009

<http://iotindiamag.com/2016/08/first-ever-iot-device-the-internet-toaster/>

Is it me or is it getting hot in here?

Attackers Can Use HVAC Systems to Control Malware on Air-Gapped Networks

By Catalin Cimpanu

September 20, 2017 11:16 AM 1



<https://www.bleepingcomputer.com/news/security/attackers-can-use-hvac-systems-to-control-malware-on-air-gapped-networks/>

Is IOT flushed away?



<https://www.wired.com/insights/2014/04/toilet-role-internet-things/>

Run for cover?

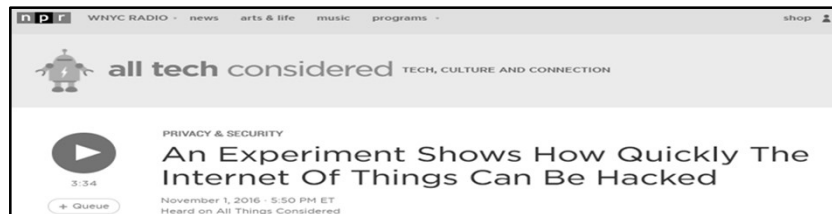

"We have basic security in place in modern devices that screen out the most obvious attacks. Really getting phished, if you will, is more of a problem where you are tricked in surrendering your password or username to a common service. If you plug in your webcam into your router or to your Wi-Fi, you're relatively safe."

<http://www.npr.org/sections/alltechconsidered/2016/11/01/500253637/an-experiment-shows-how-quickly-the-internet-of-things-can-be-hacked>

He sees you when you're sleeping....

EDITION: US

ZDNet

175,000 IoT cameras can be remotely hacked thanks to flaw, says security researcher

Researchers have found that it's trivial to remotely access one brand of security camera.

By Danny Palmer | July 31, 2017 -- 16:01 GMT (09:01 PDT) | Topic: Security



<http://www.zdnet.com/article/175000-iot-cameras-can-be-remotely-hacked-thanks-to-flaw-says-security-researcher/>

Oh those blinking lights!

ANDY GREENBERG SECURITY 02.22.17 07:00 AM

MALWARE LETS A DRONE STEAL DATA BY WATCHING A COMPUTER'S BLINKING LED



Is there a happy medium?

Trading liberty for security and privacy for convenience

Privacy and freedom are becoming currencies that we are meant to buy our safety and convenience with.



<http://us.blastingnews.com/opinion/2017/08/trading-liberty-for-security-and-privacy-for-convenience-001911705.html>

What We'll Cover ...

- Where do you fit in?
- IBM i
- Rational Developer for i (RDi)
- Current events
- Dark Web
- Free Apps?
- Hacking Around
- Wrap-up

Water Cooler Topics
I'll show you mine if you show me yours



Charles Guarino Twitter
@charlieguarino

THANK YOU !!!